

# TNLR-Q80-H1147-EX

## HF Read/Write Head – For Explosion Hazardous Areas

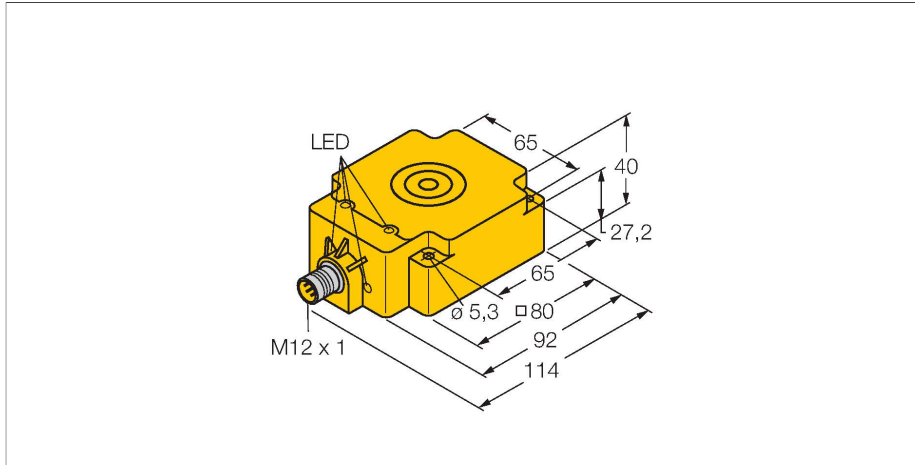

### Technical data

Type	TNLR-Q80-H1147-EX
ID	7030303
Remark to product	ATEX
Approvals	CE UKCA UL ATEX
Radio approvals	EU/RED: Europe UK SI 2017/1206: United Kingdom FCC: USA IC: Canada
Device marking	Ⓔ II 3G Ex nA II T4 II 3D Ex tD A22 IP67 T135°C
Approval acc. to	BVS 09 ATEX E 122 X
<b>Electrical data</b>	
Operating voltage	19.2...28.8 VDC
DC rated operational current	≤ 90 mA
Data transfer	Inductive coupling
Technology	HF RFID
Operating frequency	13.56 MHz
Radio communication and protocol standards	ISO 15693 NFC Typ 5
Read/Write distance max.	165 mm
Output function	4-wire, Read/Write
<b>Mechanical data</b>	
Mounting conditions	Non-flush, partially embeddable
Ambient temperature	-25...+70 °C
	For explosion hazardous areas see instruction leaflet
Design	Rectangular, Q80
Dimensions	92 x 80 x 40 mm

### Features

- Rectangular, height 40 mm
- Active face on top
- Plastic, PBT-GF30-VO
- Powered and operated only via connection to BL ident interface module
- M12 × 1 connector, connection only via BL ident extension cable
- ATEX category II 3 G, Ex zone 2
- ATEX category II 3 D, Ex zone 22

### .../S2503 Connectors

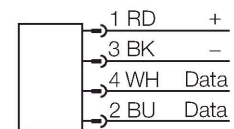

### .../S2500 Connectors

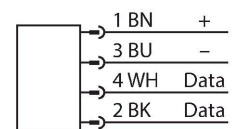

### .../S2501 Connectors

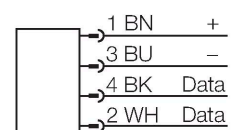

### Functional principle

## Technical data

Housing material	Plastic, PBT-GF30-V0, Yellow
Active area material	Plastic
Vibration resistance	55 Hz (1 mm)
Shock resistance	30 g (11 ms)
Protection class	IP67
MTTF	248 years acc. to SN 29500 (Ed. 99) 40 °C
Power-on indication	LED, Green
Included in delivery	SC-M12/3GD
Packaging unit	1

The HF read/write devices operating at a frequency of 13.56 MHz form a transmission zone, the size of which (0...500 mm) varies depending on the combination of read/write device and tag used.

The read/write distances mentioned here only represent standard values measured under laboratory conditions, free from any influences caused by surrounding materials.

The read/write distances of the tags for mounting in metal TW-R\*\*-(MF) were determined in metal.

Attainable distances may vary by up to 30 % due to component tolerances, mounting conditions, ambient conditions and material qualities (especially when mounted in metal). Testing of the application under real operating conditions is therefore essential, especially with on-the-fly reading and writing!

## Mounting instructions/Description

Width active area 80 mm  
B

LED	Color	Status	Meaning
\\Graphics\Pic4\00185369_0.EPS			

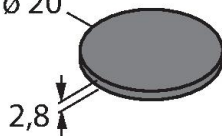
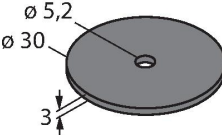
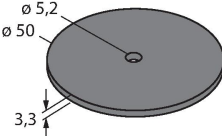
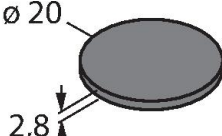
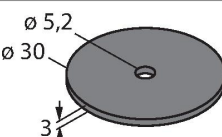
Dimensions	Type designation	Read-write distance		Transfer zone		Minimum distance between two read-write heads [mm]
		Recommended (mm)	max. [mm]	length max. [mm]	width offset max. [mm]	
	<b>IN TAG 200 SLIX2</b> 100037960	50	88	92	47	240
	<b>IN TAG 300 SLIX2</b> 100002356	60	115	116	58	240
	<b>IN TAG 500 SLIX2</b> 100027728	80	165	168	84	240
	<b>IN TAG 200 2K FRAM</b> 100002358	40	75	84	42	240
	<b>IN TAG 300 2K FRAM</b> 100002359	60	98	104	52	240

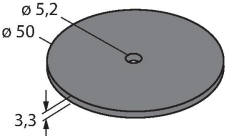
 <p>Technical drawing of a circular disc. The outer diameter is labeled as <math>\varnothing 50</math>. The inner hole diameter is labeled as <math>\varnothing 5,2</math>. The thickness of the disc is labeled as 3,3.</p>	<b>IN TAG 500 2K FRAM</b> 100002360	90	144	150	75	240
---	--	----	-----	-----	----	-----