

# DF-G3IR-KD-Q5

## Photoelectric Sensor – Photoelectric Sensor for Plastic Fibers

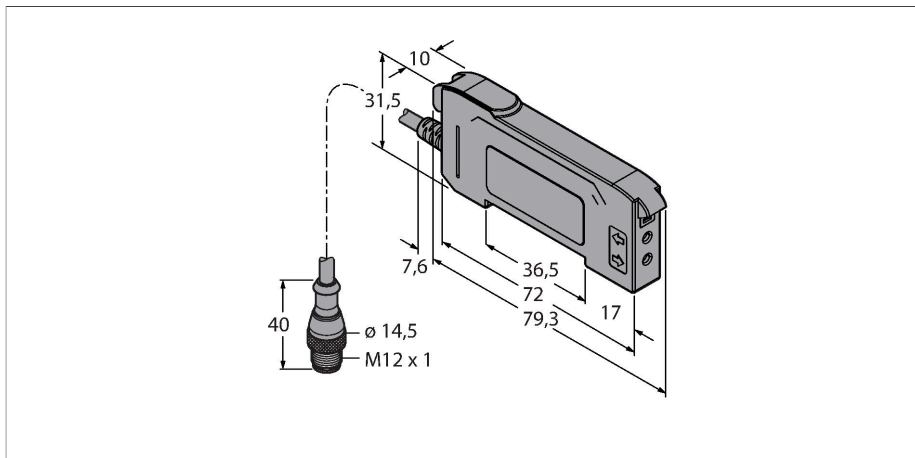

### Technical data

Type	DF-G3IR-KD-Q5
ID	3097714
<b>Optical data</b>	
Function	Fiber optic sensor
Operating mode	Plastic fiber
Fiber-optic type	Plastic
Light type	IR
Wavelength	850 nm
<b>Electrical data</b>	
Operating voltage	10...30 VDC
Residual ripple	< 10 % U <sub>ss</sub>
DC rated operational current	≤ 40 mA
Short-circuit protection	yes
Reverse polarity protection	yes
Communication protocol	IO-Link
Output function	2 normally open contact, PNP
Output 2	Switching output
Current output	100 mA
Switching frequency	1 kHz
Readiness delay	≤ 500 ms
Response time typical	< 0.5 ms
Setting option	Push Button Remote Teach
<b>IO-Link</b>	
IO-Link specification	V 1.1
IO-Link port type	Class A
Communication mode	COM 2 (38.4 kBaud)

### Features

- Cable with male end M12 × 1
- Infrared
- Programming via teach cable or multi-function button
- Operating voltage: 10...30 VDC
- IO-Link
- 2 × PNP output, changeover contact
- Light/dark operation

### Wiring diagram

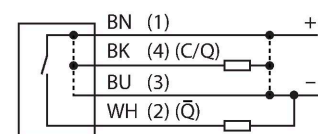

### Functional principle

Glass or plastic fibers are the optimum choice for high-temperature applications and limited spaces. Optical fibers transfer the light from the sensor to a remote object. Single optical fibers are suited for opposed sensing mode, while bifurcated optical fibers are best suited for diffuse sensing mode. The basic units of the third generation of the DF-G series offer very long ranges with standard optical fibers. You have also two 4-digit 7-segment displays for simultaneous display of limit value and instant reading of the amount of received light. Via the multifunction button, you can make various settings and change the switching threshold.

## Technical data

Process data width	16 bit
Function Pin 4	IO-Link
Function Pin 2	DI
Maximum cable length	20 m
Profile support	Smart Sensor Profil
Included in the SIDI GSDML	Yes
<b>Mechanical data</b>	
Design	Rectangular, DF-G3
Dimensions	79.3 x 10 x 33 mm
Housing material	Plastic, Thermoplastic material, Black
Electrical connection	Cable with connector, M12 × 1, 0.15 m, PVC
Number of cores	4
Ambient temperature	-10...+55 °C
Relative humidity	0...90 %
Protection class	IP50
Special features	keep/defer
Switching state	LED, Yellow
Excess gain indication	Dual Digital Displays
<b>Tests/approvals</b>	
Approvals	CE, cULus listed

## Accessories

Dimension drawing	Type	ID	
	RKC4.4T-2/TEL	6625013	Connection cable, female M12, straight, 4-pin, cable length: 2 m, sheath material: PVC, black; cULus approval; other cable lengths and qualities available, see <a href="http://www.turck.com">www.turck.com</a>
	WKC4.4T-2/TEL	6625025	Connection cable, female M12, angled, 4-pin, cable length: 2 m, sheath material: PVC, black; cULus approval; other cable lengths and qualities available, see <a href="http://www.turck.com">www.turck.com</a>

## Accessories

Dimension drawing	Type	ID	
	PBT16U	3042822	Plastic fiber-optic sensor, operating mode: Diffuse mode, threaded sleeve M3 x 0.75 mm, field wireable wire without end tip, polyethylene sheath, ambient temperatures -30 °C...+70 °C

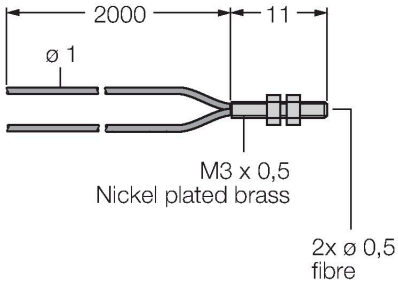
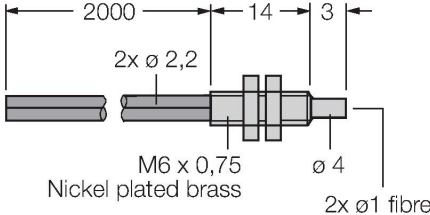
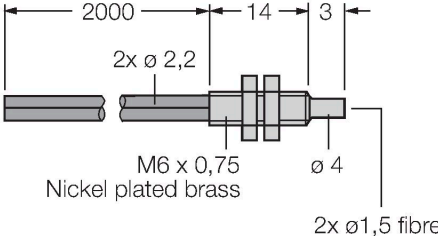
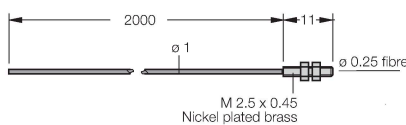
Dimension drawing	Type	ID	
 <p>Dimension drawing of PBT26U sensor. It shows a long cable with a diameter of <math>\varnothing 1</math> mm. The total length is 2000 mm. The sensing tip is 11 mm long and features a threaded bush with an M3 x 0,5 thread. The tip is made of nickel-plated brass and contains two <math>\varnothing 0,5</math> mm fibers.</p>	PBT26U	3026080	Plastic fiber, sensing mode: Diffuse mode, threaded bush M3 x 0.75 mm, preassembled wire without end tip, polyethylene jacket, ambient temperatures -30 °C...+70 °C
 <p>Dimension drawing of PBT46U sensor. It shows a long cable with a diameter of <math>\varnothing 2,2</math> mm. The total length is 2000 mm. The sensing tip is 14 mm long and features a threaded sleeve with an M6 x 0,75 thread. The tip is made of nickel-plated brass and contains two <math>\varnothing 1</math> mm fibers. The diameter of the tip is <math>\varnothing 4</math> mm.</p>	PBT46U	3025967	Plastic fiber-optic sensor, operating mode: Diffuse mode, threaded sleeve M3 x 0.75 mm, field wireable wire without end tip, polyethylene sheath, ambient temperatures -30 °C...+70 °C
 <p>Dimension drawing of PBT66U sensor. It shows a long cable with a diameter of <math>\varnothing 2,2</math> mm. The total length is 2000 mm. The sensing tip is 14 mm long and features a threaded sleeve with an M6 x 0,75 thread. The tip is made of nickel-plated brass and contains two <math>\varnothing 1,5</math> mm fibers. The diameter of the tip is <math>\varnothing 4</math> mm.</p>	PBT66U	3039982	Plastic fiber-optic sensor, operating mode: Diffuse mode, threaded sleeve M6 x 0.75 mm, pre-assembled wire without end tip, polyethylene sheath, ambient temperatures -30 °C...+70 °C
 <p>Dimension drawing of PIT16U sensor. It shows a long cable with a diameter of <math>\varnothing 1</math> mm. The total length is 2000 mm. The sensing tip is 11 mm long and features a threaded sleeve with an M 2.5 x 0.45 thread. The tip is made of nickel-plated brass and contains one <math>\varnothing 0,25</math> mm fiber.</p>	PIT16U	3039983	Plastic fiber-optic sensor, operating mode: Opposed mode, threaded sleeve M3 x 0.5 mm, field wireable wire without end tip, polyethylene sheath, ambient temperatures -30 °C...+70 °C

Dimension drawing	Type	ID	
	PIT26U	3026079	Plastic fiber, sensing mode: Opposed mode, threaded bush M3 x 0.5 mm, preassembled wire without end tip, polyethylene jacket, ambient temperatures -30 °C...+70 °C

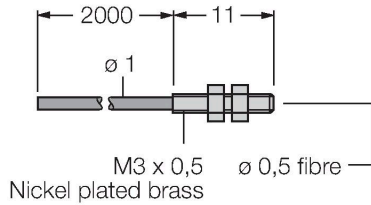

	PIT46U	3026034	Plastic fiber-optic sensor, operating mode: Opposed mode, threaded sleeve M3 x 0.5 mm, field wireable wire without end tip, polyethylene sheath, ambient temperatures -30 °C...+70 °C
--	--------	---------	---

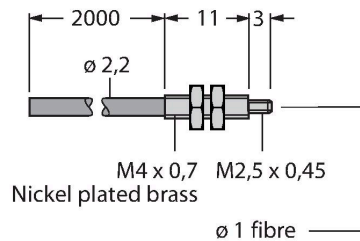

	PIT66U	3039899	Plastic fiber-optic sensor, operating mode: Opposed mode, threaded sleeve M3 x 0.5 mm, field wireable wire without end tip, polyethylene sheath, ambient temperatures -30 °C...+70 °C
--	--------	---------	---

