

Safety Light Curtain Receiver Cascadable SLLCR14-560P8

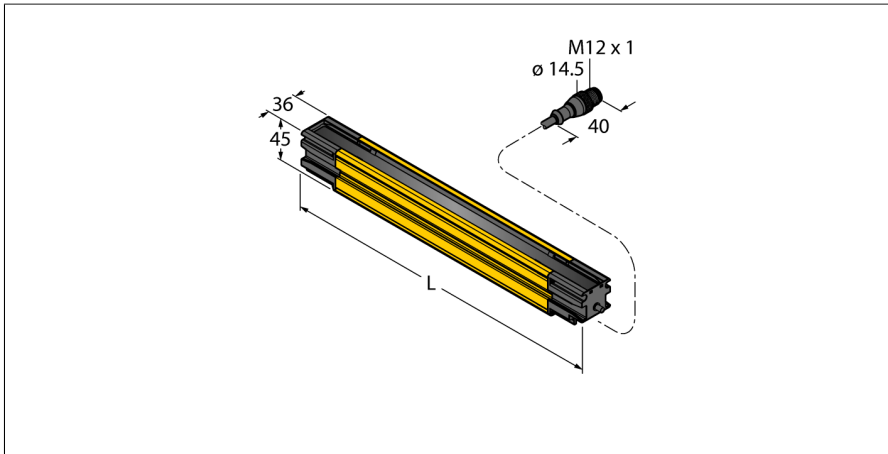

Type	SLLCR14-560P8
ID	3089141

Optical data	
Function	Light screen
Light type	IR
Optical resolution	14 mm
Range	100...12000 mm
Scan field	560 mm
Number of beams	64
With muting function	No
Scan Code	Adjustable

Electrical data	
Operating voltage U_s	20.4...27.6 VDC
DC rated operating current I_s	≤ 106 mA
Max. current safe output	500 mA
Short-circuit protection	yes
Reverse polarity protection	yes
Output function	2 x NO contact, 2 x PNP
Voltage output	0...22.5 V
Current output	0 mA
Number of safe semiconductor outputs	2
Insulation class	III
Response time typical	< 18.4 ms
With restart interlock	yes
Blanking function	yes
Max. DC switching capacity	12 W

- Rugged housing
- Protection class IP67
- Diagnosis display for status and error indication
- Scan field L: 560 mm
- Optical Alignment aid
- No blind zone
- Range: 0.1...12 m
- Resolution: 14 mm
- Operating voltage: 24 VDC
- Automatic cascade configuration
- No restart interlock
- Safety light curtain type 4 acc. to IEC 61496-1 and 61496-2
- Category 4 Ple acc. to EN ISO 13849-1
- SIL 3 acc. to IEC 61508 SIL 3 and CL3 acc. to IEC 62061
- Shock and vibration resistant acc. to IEC 61496-1

Wiring Diagram

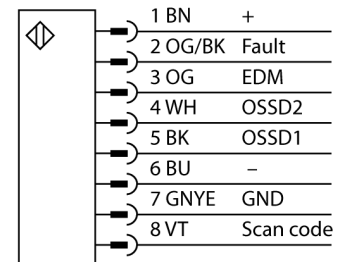

Functional principle

The self-monitoring safety light screens with redundant switching outputs are available in

Mechanical data	
Design	Rectangular, EZ-Screen LS
Housing material	Metal, AL, Yellow polyester
Lens	acrylic, Plastic
Cascadable	Yes
Electrical connection	Cable with connector, M12 × 1, 0.3 m
Number of cores	8
Core cross-section	0.25 mm ²
Ambient temperature	-20...+55 °C
Protection class	IP65 IP67
Power-on indication	
Power-on indication	LED, Yellow
Switching state	LED, Red
Error indication	LED, red
Tests/approvals	
Vibration resistance	10–55 Hz at 0.35 mm
Shock test	10 g at 16 ms (6000 cycles)
Approvals	CE, cULus, PL e acc. to EN ISO 13849-1:2008, SIL 3 acc. to IEC 61508

lengths up to 1.8 m and resolutions of 14, 23 or 40 mm. The devices are available individually or in pairs and are synchronized optically - a physical connection between transmitter and receiver is not necessary. For versions with cascading no further configuration is necessary. The setting is made automatically. Up to 4 couples of any length and resolution can be connected together. The dual scan of each receiver provides immunity against EMI, radio wave, ambient or strobe lights and welding sparks. All recipients have no restart interlock – an automatic reset is performed. If required individual beams can be hidden.

The robust and sealed housing is ideally suited for industrial use. Status and error code can be read out in case of need via the diagnostic display. For easy mounting, LEDs indicate the proper alignment of each segment.