

Accessories

Shield Plate

For Encoders RI-QR24

SP3-QR24

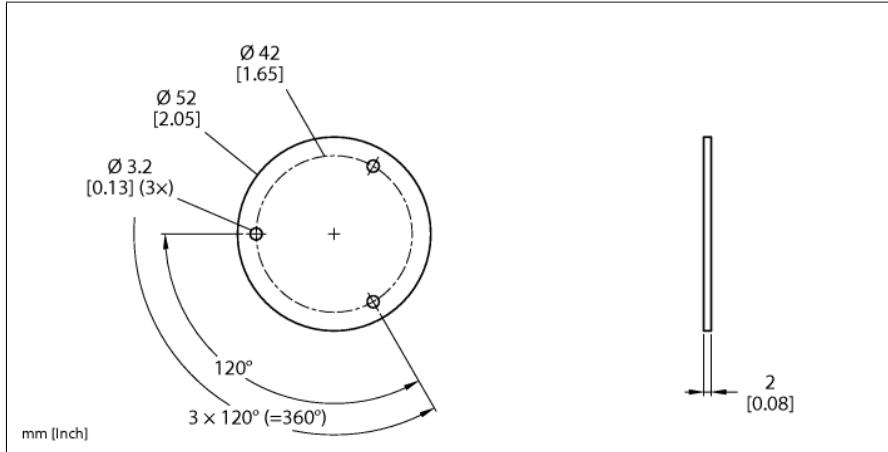

- Positioning element
- Hollow shaft, internal diameter 6 mm
- Incl. mounting option for shaft adapter

Type	SP3-QR24
ID	1590958
Housing material	Aluminium