

TN-UHF-CBL-HF240-RPTNC-1-SMA

Accessories – Coaxial Cable for Passive UHF Antennas

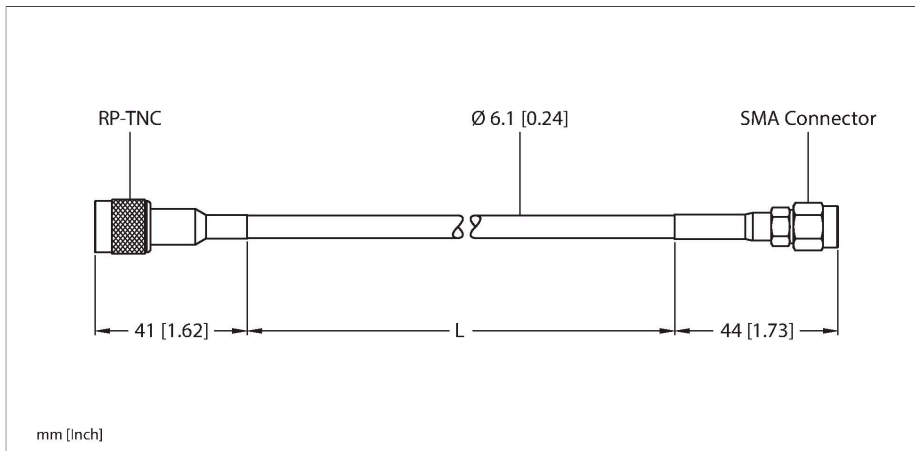

Technical data

Type	TN-UHF-CBL-HF240-RPTNC-1-SMA
ID	100028191
Cable quality	1 m
Damping	0.25 dB
Packaging unit	1

Features

- RP-TNC to SMA