

LI900P0-Q25LM0-IOLX3-H1141

Inductive linear position sensor IO-Link

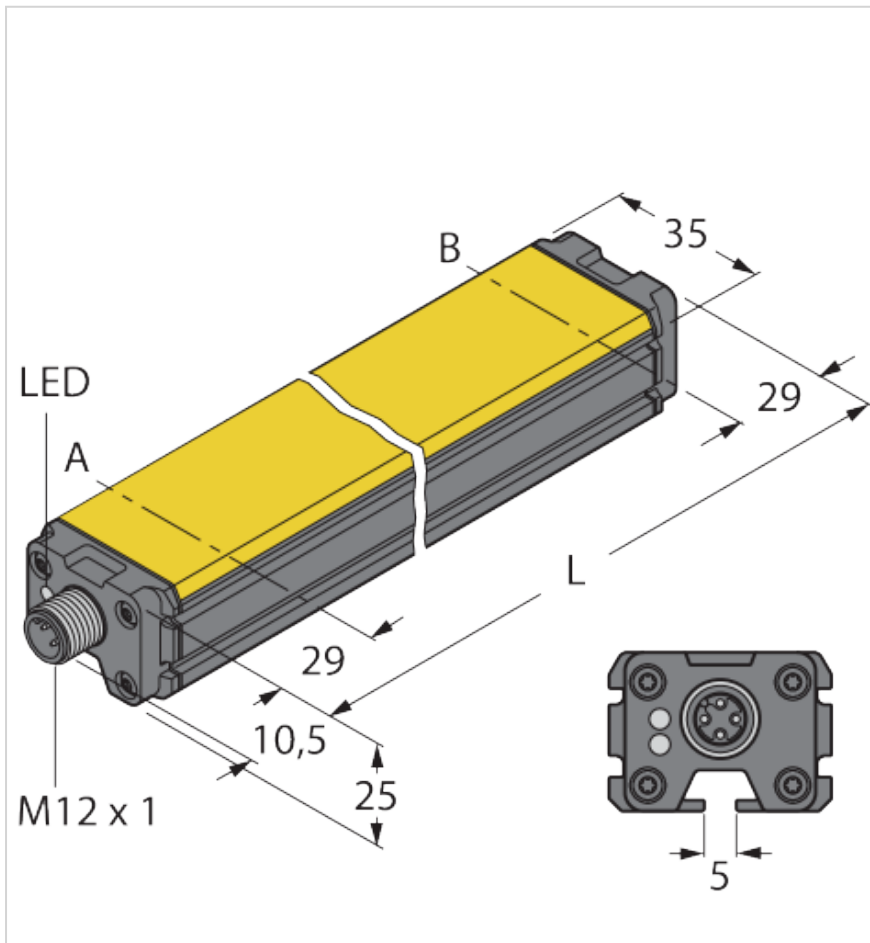

Typ	LI900P0-Q25LM0-IOLX3-H1141
Ident-No.	100012832

Technical data

General data	
Measuring principle	Inductive
Detection area/measuring range	
Blind zone a	29 mm
Blind zone b	29 mm
Nominal distance	1,5 mm
Measuring range	900 mm
Power supply	

Features

- Rectangular, aluminum/plastic
- Versatile mounting options
- Measuring range indication via LED
- Immune to electromagnetic interference
- Extremely short blind zones
- Process value in 32-bit IO-Link telegram
- 15–30 VDC
- Connector, M12 × 1, 4-pin

Technical data

Operating voltage U_B	15...30 VDC
Electrical data	
Short-circuit protection	yes
Wire break/reverse polarity protection	yes (voltage supply)
Current consumption	< 100 mA
Diagnostic	Positioning element not within detection range via diagnostic bit
Isolation test voltage	$\leq 0,5$ kV
Residual ripple	≤ 10 % U_{SS}
Sample rate	5000 Hz
Interfaces	
Communication protocol	IO-Link
Accuracy/deviation	
Resolution	16 bit
Linearity deviation	0,035 % f.s. also under the influence of shock and vibration
Hysteresis	omitted as a matter of principle
Repeat accuracy	$\leq 0,02$ % v. E.
Temperature drift	$\leq \pm 0,0001$ %/K
IO-Link	
IO-Link specification	V 1.1
Communication mode	COM 3 (230.4 kBaud)
Transmission rate	COM 3
Process data width	32 bit
Minimum cycle time	1 ms
Function pin 4	IO-Link
Programming	FDT/DTM
Mechanical data	
Design	Profile, Q25L
Construction type designation	Q25L
Dimensions	958 mm x 35 mm x 25 mm
Housing material	Aluminum/plastic, PA6-GF30, Anodized
Active area material	Plastic, PA6-GF30
Electrical connection	Connector, M12 x 1
Ambient conditions	
Ambient temperature	-25...+70 °C
Pollution degree	3
Shock resistance (EN 60068-2-27)	200 g; 4 ms $\frac{1}{2}$ sine

Wiring diagram

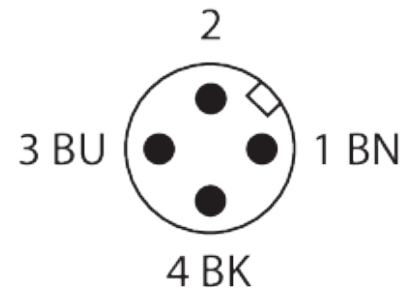
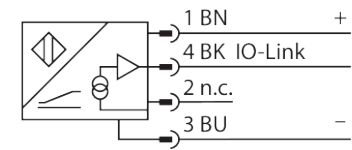

Functional principle

The measuring principle of linear position sensors is based on oscillation circuit coupling between the positioning element and the sensor, whereby an output signal is provided proportional to the position of the positioning element. The rugged sensors are maintenance- and wear-free thanks to the contactless operating principle. They impress with their excellent repeatability, resolution and linearity within a broad temperature range. The innovative technology ensures high immunity to electromagnetic DC and AC fields.

Technical data

Vibration resistance (EN 60068-2-6)	20 g; 1.25 h/axis; 3 axes
Protection class	IP67
Tests/approvals	
UL registration number	E210608
MTTF	138 Years acc. to SN 29500 (Ed. 99) 20 °C
Displays/controls	
Measuring range display	multifunction LED, green, yellow, yellow flashing
Power-on indication	LED, Green

Assembly instructions

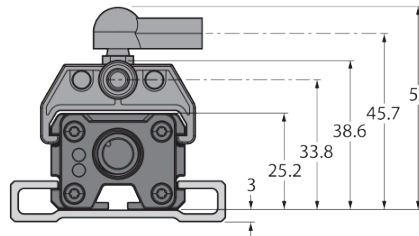
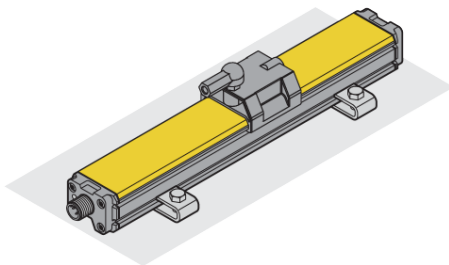

Installation information:
Extensive mounting accessories provide various options for installation. The measuring principle of oscillation circuit coupling makes the linear position sensor immune to magnetized ferrous chips and other interference fields.

Measuring range display via LED

Green:

Positioning element is within the measuring range

Yellow:

Positioning element is within the measuring range, low signal intensity (e.g. distance too large)

Yellow flashing:

Positioning element is outside the detection range

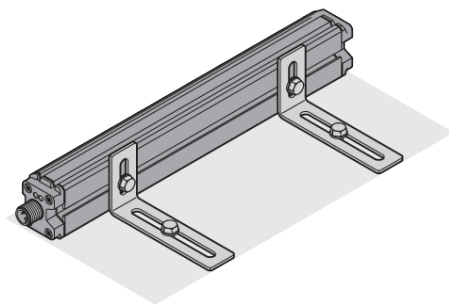

Mounting accessories

P1-LI-Q25L

6901041

Guided positioning element for linear position sensors LI-Q25L, inserted in the groove of the sensor

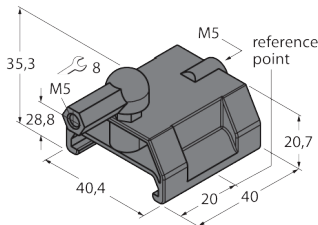

P2-LI-Q25L

6901042

Floating positioning element for linear position sensors LI-Q25L; the nominal distance to the sensor is 1.5 mm; pairing with the linear position sensor at a distance of up to 5 mm or misalignment tolerance of up to 4 mm.

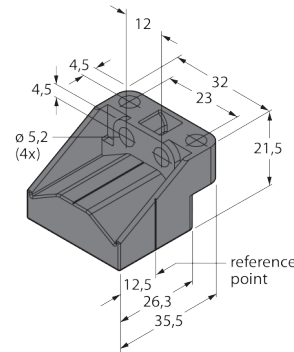

P3-LI-Q25L

6901044

Floating positioning element for Li-Q25L linear position sensors; operational at an offset of 90°; nominal distance to sensor 1.5 mm; pairing with linear position sensor at a distance of up to 5 mm; misalignment tolerance of up to 4 mm

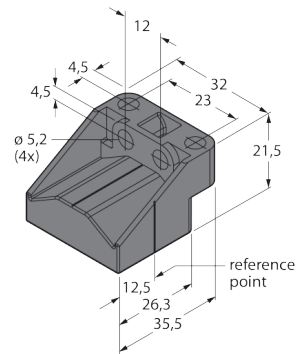

P6-LI-Q25L

6901069

Floating positioning element for linear position sensors LI-Q25L; the nominal distance to the sensor is 1.5 mm; pairing with the linear position sensor at a distance of up to 5 mm or misalignment tolerance of up to 4 mm.

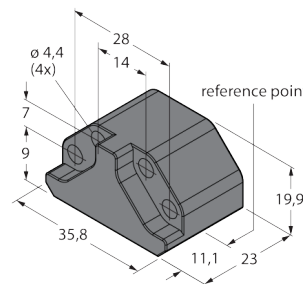

P7-LI-Q25L

6901087

Guided positioning element for linear position sensors LI-Q25L, without ball joint

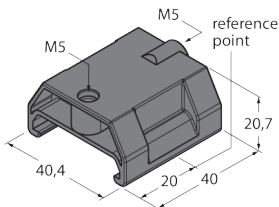

M1-Q25L

6901045

Mounting foot for linear position sensors LI-Q25L; aluminum; 2 pcs. per bag

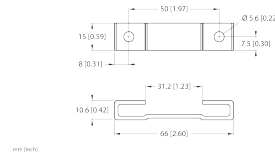

M2-Q25L.

6901046

Mounting foot for linear position sensors LI-Q25L; aluminum; 2 pcs. per bag

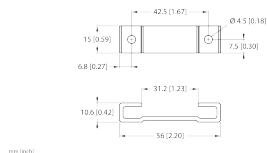

M4-Q25L

6901048

Mounting bracket and sliding block for LI-Q25L linear position sensors; material: stainless steel; 2 pcs. per bag



Mounting accessories

MN-M4-Q25

6901025

Sliding block with M4 thread for the backside profile of the LI-Q25L linear position sensor; material: galvanized steel; 10 pcs. per bag

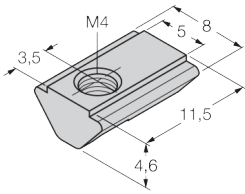

AB-M5

6901057

Axial joint for guided positioning element

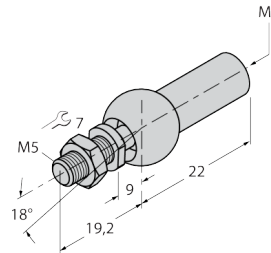

ABVA-M5

6901058

Axial joint for guided positioning elements; material: stainless steel

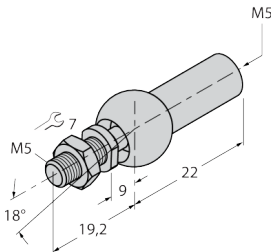

RBVA-M5

6901059

Angle joint for guided positioning element; material: stainless steel

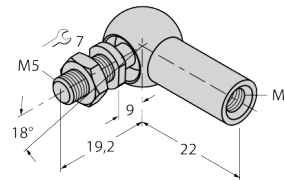

Connection accessories

RKC4T-2-RSC4T/TXL

6625604

Extension cable, M12 female connector, straight, 3-pin to M12 male connector, straight, 3-pin; cable length: 2 m, jacket material: PUR, black; cULus approval

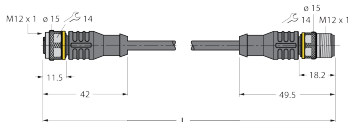

RKC4T-2/TXL

6625500

Connection cable, M12 female connector, straight, 3-pin, cable length: 2 m, jacket material: PUR, black; cULus approval

