

FP100-300L-30-NA-2M

Flow Meter – Immersion Sensor without Integrated Processing Unit

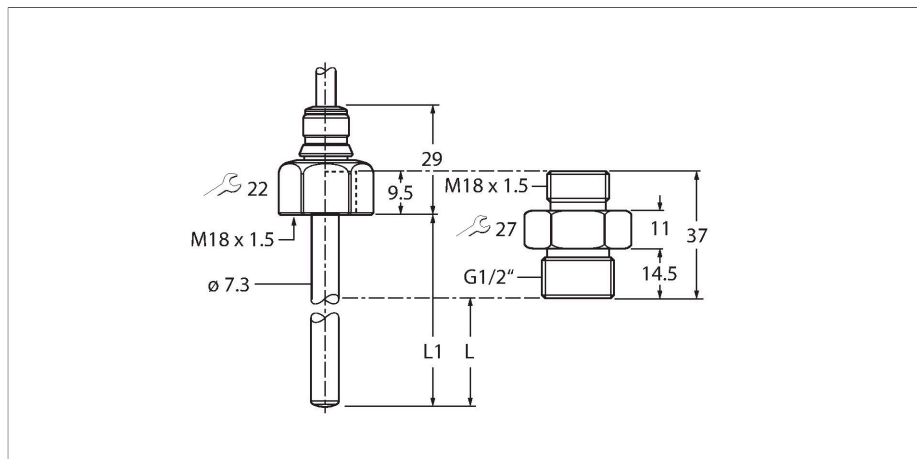

Features

- Screw-in adaptor with process connection G1/2" male thread included in delivery
- Housing material: 1.4571 (316Ti)
- Immersion depth 16.9 mm
- Flow monitoring for liquid media
- Protection classes IP66, IP67 and IP69K
- Cable connection

Wiring diagram

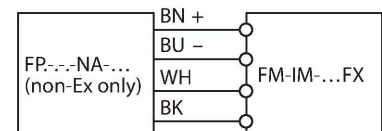

Technical data

Type	FP100-300L-30-NA-2M
ID	100001055
Medium temperature	-25...+85 °C
Application area	
Mounting conditions	Immersion sensor
Application area	liquids
Bar length (L1)	45 mm
Immersion depth (L)	16.9 mm, When using the supplied adapter
Pressure resistance	300 bar
Response time T09	6 s
Response time T05	3 s
Standard flow range	3...300 cm/s
Extended flow range	Any axial alignment of the sensor rod in the medium
Extended flow range comment	1...300 cm/s
Temperature gradient	Directed inflow to punch mark ±20 °
	≤ 300 K/min
Mechanical data	
Housing material	Stainless steel, 1.4571 (AISI 316Ti)
Adapter material	Stainless steel 1.4571 (316Ti)
Materials (contact with media)	Stainless steel 1.4571 (AISI 316Ti), FKM O-ring, AFM flat seal
Process connection sensor	M18 x 1.5 female thread
Process connection adapter	M18 x 1.5 male thread; G 1/2" male thread
Electrical connection	Cable

Functional principle

The flow sensor functions according to the calorimetric principle. The distinctive feature of this principle is that the flow rate correlates directly to the thermal loss of energy in the probe. The increased loss of energy is therefore a direct measure of an increased flow rate.

Technical data

Protection class	IP66 IP67 IP69K
------------------	-----------------------

Environmental conditions

Ambient temperature	-40...+85 °C
Storage temperature	-40...+80 °C
Shock resistance	50 g (11 ms) DIN EN 60068-2-27
Vibration resistance	20 G (55...2000 Hz)DIN EN 60068-2-6

Tests/approvals

Approvals	CE cULus
UL registration number	E516036
MTTF	120 years acc. to SN 29500 (Ed. 99) 40 °C

Accessories

FAA-A1-1.4571

100001987

Screw-in adapter for immersion sensors from the series FS.., FP..; material: Stainless steel 1.4571 (316Ti); process connection: N1/2"

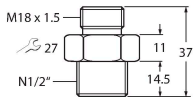

FAA-80-1.4571

100001988

Screw-in adapter for immersion sensors from the series FS.., FP..; material: Stainless steel 1.4571 (316Ti); process connection: G1/2"

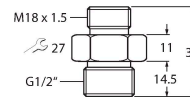

FAA-04-1.4571

100001989

Screw-in adapter for immersion sensors from the series FS.., FP..; material: Stainless steel 1.4571 (316Ti); process connection: G1/4"

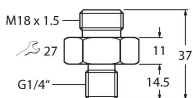

FAA-34-1.4571

100001990

Screw-in adapter for immersion sensors from the series FS.., FP..; material: Stainless steel 1.4571 (316Ti); process connection: N3/4"

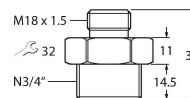

FAA-81-1.4571

100001991

Screw-in adapter for immersion sensors from the series FS.., FP..; material: Stainless steel 1.4571 (316Ti); process connection: G3/4"

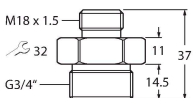

Accessories

Dimension drawing	Type	ID	
	FM-IM-3UP63FX	100000818	Signal processor for non-Ex flow sensors from the FP...-...-NA-... family; operating voltage 20...30 VDC; LED bar for displaying flow speed and medium temperature; IO-Link device with transistor outputs for flow, temperature and errors
	FM-IM-3UR38FX	100000820	Signal processor for non-Ex flow sensors from the FP...-...-NA-... family; operating voltage 20...250 VAC; LED bar for displaying flow speed and medium temperature; IO-Link device with relay outputs for flow, temperature and errors
	FM-IM-2UPLI63FX	100000819	Signal processor for non-Ex flow sensors from the FP...-...-NA-... family; operating voltage 20...30 VDC; LED bar for displaying flow speed and medium temperature; IO-Link device with analog output for flow and transistor outputs for temperature and errors